

04794 SIFONE PER LAVELLO A 1 VIA "FIASCA"

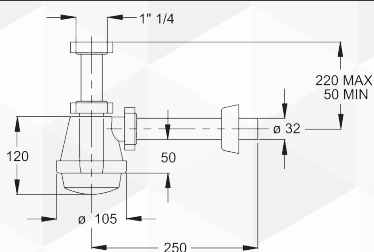

CODICE	VARIANTE	COD.PRODUTTORE	U.M.	M.V.	CF	LISTINO
0479402	1"1/4 - Ø32	1370CP54B0	PZ	1	25	
0479404	1"1/2 - Ø40	1310CP40B0	PZ	1	25	

Materiale: Polipropilene PP. Colore: Bianco



0479402 Portata 46,6 l/min
Colonna d'acqua 50 mm

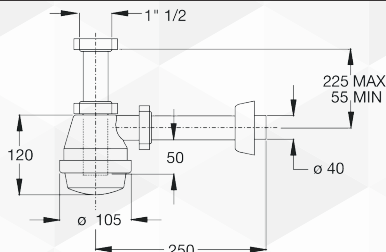

0479404 Portata 65 l/min
Colonna d'acqua 50 mm



04798 SIFONE PER LAVELLO A 2 VIE "FIASCA"



CODICE	VARIANTE	COD.PRODUTTORE	U.M.	M.V.	CF	LISTINO
0479802	1"1/4 - Ø32	1380CP54B0	PZ	1	25	
0479804	1"1/2 - Ø40	1320CP40B0	PZ	1	25	

Per lavelli cucina a due bacinelle.

Materiale: Polipropilene PP. Colore: Bianco

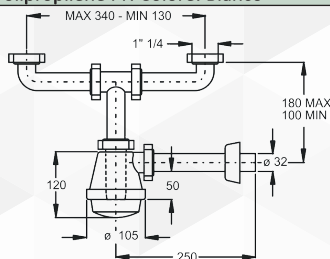

0479802 Portata 29 l/min

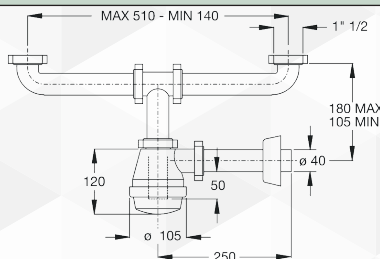

0479804 Portata 50,8 l/min



04796 SIFONE PER LAVELLO A 1 VIA SALVASPAZIO "SPACE 1"



CODICE	VARIANTE	COD.PRODUTTORE	U.M.	M.V.	CF	LISTINO
04796	1"1/2 - Ø40	1510CP40B0	PZ	1	1	

Autopulente. Una entrata, quattro attacchi ausiliari

Attacco piletta 1"1/2 scarico Ø 40 mm. Materiale: Polipropilene PP Bianco



1) Collettore verticale per distanze molto lunghe fra piletta e punto di scarico



2) Collettore verticale con collegamento alla piletta in posizione laterale e più bassa (3 possibilità) idoneo per portarsi alla giusta distanza fra piletta e punto di scarico.



3) Collettore orizzontale idoneo per distanze molto limitate fra piletta e punto di scarico

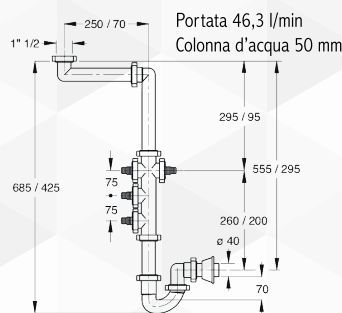

Portata 46,3 l/min
Colonna d'acqua 50 mm

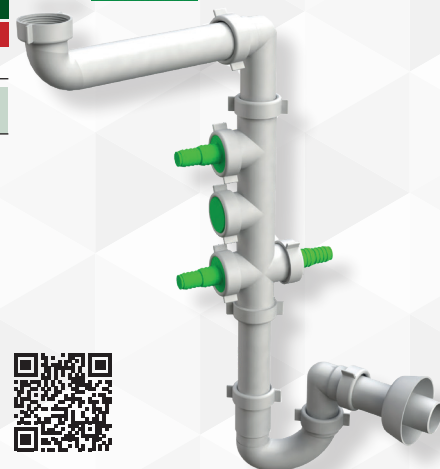

04800 SIFONE PER LAVELLO A 2 VIE SALVASPAZIO "SPACE 2"



CODICE	VARIANTE	COD.PRODUTTORE	U.M.	M.V.	CF	LISTINO
04800	1"1/2 - Ø40	1520CP40B0	PZ	1	1	

Autopulente. Due entrate, tre attacchi ausiliari.

Materiale: Polipropilene PP Bianco

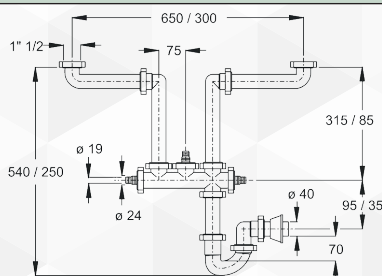

Portata 46,3 l/min
Colonna d'acqua 50 mm

