

0279510

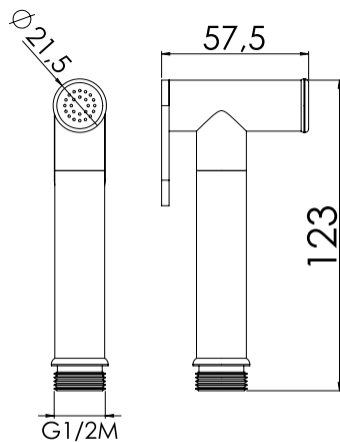

0279512

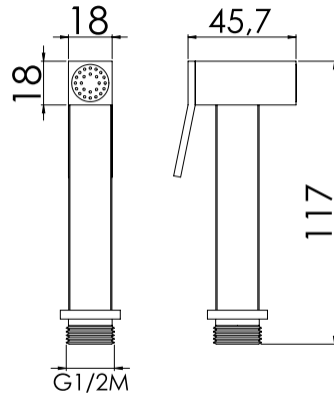

0279514